



Multi output SAW Oscillator (MOSO)
OUTPUT : LVDS



Product Number
X1M000421xxxx00

MG7050VAN

Feature

- Ultra Low jitter : 0.3 ps Max.
- 2 or 4 outputs and it is able to reduce fan-out buffers
- Frequency range : 100 MHz to 700 MHz
- Supply voltage : 2.5 V / 3.3 V
- External dimensions : 7.0 × 5.0 × 1.6 mm
- Output : LVDS (2 or 4 outputs)

Application

Server, Storage, Network Instrument.

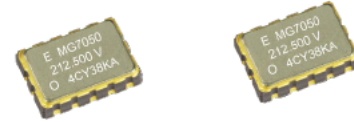

Specifications (characteristics)

Item	Symbol	Specifications		Conditions / Remarks	
Output frequency range	fo	100 MHz to 700 MHz		Please contact us about available frequencies.	
		100MHz, 106.25MHz, 125MHz, 150MHz, 156.25MHz, 200MHz, 212.5MHz, 250MHz, 300MHz, 312.5MHz		Standard frequency	
Supply voltage	V _{CC}	D: 2.5 V ± 0.125 V	C: 3.3 V ± 0.33 V	V _{CC} , V _{CC1} and V _{CC2} need same voltage	
Storage temperature	T _{stg}	-55 °C to +125 °C		Store as bare product after packing	
Operating temperature	T _{use}	A: 0 °C to +70 °C, B: -20 °C to +70 °C D: -5 °C to +85 °C			
Frequency tolerance *1	f _{tol}	J: ±50 × 10 ⁻⁶ , L: ±100 × 10 ⁻⁶			
Current consumption	I _{CC}	35 mA Typ., 50 mA Max.	45 mA Typ., 56 mA Max.	2-outputs	OE=V _{CC} , L_LVDS=100 Ω
		40 mA Typ., 66 mA Max.	50 mA Typ., 72 mA Max.	4-outputs	
Disable current	I _{dis}	7 mA Typ., 18 mA Max.	8 mA Typ., 20 mA Max.	OE=GND	
Symmetry	SYM	45 % to 55 %		At outputs crossing point	
Output voltage	V _{OD}	247 mV to 454 mV		DC characteristics	
	V _{OS}	1.125 V to 1.375 V			
Output load condition	L_LVDS	100 Ω		Connected between OUTnP and OUTnN	
Input voltage	V _{IH}	70 % V _{CC} Min.		OE and FSEL terminals	
	V _{IL}	30 % V _{CC} Max.			
Rise time / Fall time	tr / tf	200 ps Typ., 400 ps Max.		Between 20 % and 80 % of differential output peak to peak voltage	
Start-up time	t _{str}	5 ms Typ., 10 ms Max.		Time at minimum supply voltage to be 0 s	
Phase Jitter	t _{pj}	0.19 ps Typ.	0.16 ps Typ.	fo=100 MHz	Offset frequency: 12 kHz to 20 MHz
		0.18 ps Typ.	0.15 ps Typ.	fo=125 MHz	
		0.17 ps Typ.	0.14 ps Typ.	fo=156.25 MHz	
		0.15 ps Typ.	0.13 ps Typ.	fo=212.5 MHz	
		0.12 ps Typ.	0.11 ps Typ.	fo=312.5 MHz	
		0.06 ps Typ.	0.05 ps Typ.	fo=700 MHz	
		0.3 ps Max.			
Skew	t _{skew}	20 ps Typ., 50 ps Max.		FSEL=H	
Aging	f _{age}	N: ±10 × 10 ⁻⁶ /year Max.		First year	+25 °C, V _{CC} =2.5 V, 3.3 V
		A: Included in Frequency tolerance *2		10 years	

*1 Frequency tolerance includes initial frequency tolerance, temperature variation, supply voltage change and reflow drift.

*2 "A" is not acceptable when Frequency tolerance is "J" and Operating temperature is "B" or "D".

Product Name
(Standard form)

MG7050 V AN 156.250000MHz ④ ⑤ ⑥ ⑦ ⑧ ⑨ (⑦⑧⑨:JDA, JBA are not available)

- ① Model
② Output (L: LVDS)
③ Frequency
④ Number of outputs (2: 2-outputs, 4: 4-outputs)
⑤ "A": Fixed
⑥ Supply voltage
⑦ Frequency tolerance
⑧ Operating temperature
⑨ Frequency aging

⑥ Supply voltage	
C	3.3 V Typ.
D	2.5 V Typ.

⑦ Frequency tolerance	
J	±50 × 10 ⁻⁶
L	±100 × 10 ⁻⁶

⑧ Operating temp.	
A	0 °C to +70 °C
B	-20 °C to +70 °C
D	-5 °C to +85 °C

⑨ Frequency aging	
A	Frequency tolerance include aging
N	Frequency tolerance exclude aging

Block diagram

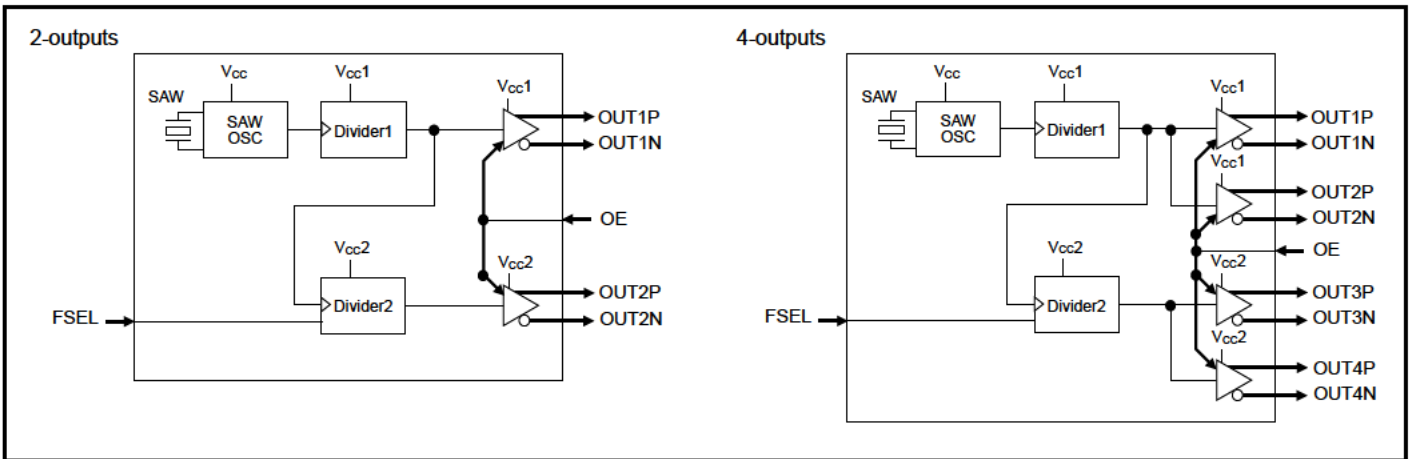

FSEL function

2-outputs		OUT1	OUT2
4-outputs		OUT1 / OUT2	OUT3 / OUT4
FSEL	H	fo	fo
	L	fo	fo/2

External dimensions

(Unit :mm)

Footprint (Recommended) (Unit :mm)

Pin	Connection	
	2-outputs	4-outputs
1	V _{cc1}	
2	GND	OUT1P
3	OUT1P	OUT1N
4	OUT1N	OUT2P
5	GND	OUT2N
6	FSEL	
7	OE	
8	GND	OUT3N
9	OUT2N	OUT3P
10	OUT2P	OUT4N
11	GND	OUT4P
12	V _{cc2}	
13	V _{cc}	
14	GND	

OE pin = "H" : Specified frequency output.
 OE pin = "L" : Output is high impedance
 #14 is connected to the cover.

To maintain stable operation, provide a 0.01 μF to 0.1 μF by-pass capacitor at a location as near as possible to the power source terminal of the crystal product (between V_{cc}, V_{cc1}, V_{cc2} - GND).

PROMOTION OF ENVIRONMENTAL MANAGEMENT SYSTEM CONFORMING TO INTERNATIONAL STANDARDS

At Seiko Epson, all environmental initiatives operate under the Plan-Do-Check-Action (PDCA) cycle designed to achieve continuous improvements. The environmental management system (EMS) operates under the ISO 14001 environmental management standard.

All of our major manufacturing and non-manufacturing sites, in Japan and overseas, completed the acquisition of ISO 14001 certification.

ISO 14000 is an international standard for environmental management that was established by the International Standards Organization in 1996 against the background of growing concern regarding global warming, destruction of the ozone layer, and global deforestation.

WORKING FOR HIGH QUALITY

In order provide high quality and reliable products and services than meet customer needs, Seiko Epson made early efforts towards obtaining ISO9000 series certification and has acquired ISO9001 for all business establishments in Japan and abroad. We have also acquired IATF 16949 certification that is requested strongly by major automotive manufacturers as standard.

IATF 16949 is the international standard that added the sector-specific supplemental requirements for automotive industry based on ISO9001.

► Explanation of the mark that are using it for the catalog

	► Pb free.
	► Complies with EU RoHS directive. *About the products without the Pb-free mark. Contains Pb in products exempted by EU RoHS directive. (Contains Pb in sealing glass, high melting temperature type solder or other.)
	► Designed for automotive applications such as Car Multimedia, Body Electronics, Remote Keyless Entry etc.
	► Designed for automotive applications related to driving safety (Engine Control Unit, Air Bag, ESC etc).

NOTICE : PLEASE READ CAREFULLY BELOW BEFORE THE USE OF THIS DOCUMENT ©Seiko Epson Corporation 2020

1. The content of this document is subject to change without notice. Before purchasing or using Epson products, please contact with sales representative of Seiko Epson Corporation ("Epson") for the latest information and be always sure to check the latest information published on Epson's official web sites and resources.
2. This document may not be copied, reproduced, or used for any other purposes, in whole or in part, without Epson's prior consent.
3. Information provided in this document including, but not limited to application circuits, programs and usage, is for reference purpose only. Epson makes no guarantees against any infringements or damages to any third parties' intellectual property rights or any other rights resulting from the information. This document does not grant you any licenses, any intellectual property rights or any other rights with respect to Epson products owned by Epson or any third parties.
4. Using Epson products, you shall be responsible for safe design in your products; that is, your hardware, software, and/or systems shall be designed enough to prevent any critical harm or damages to life, health or property, even if any malfunction or failure might be caused by Epson products. In designing your products with Epson products, please be sure to check and comply with the latest information regarding Epson products (including, but not limited to this document, specifications, data sheets, manuals, and Epson's web site). Using technical contents such as product data, graphic and chart, and technical information, including programs, algorithms and application circuit examples under this document, you shall evaluate your products thoroughly both in stand-alone basis and within your overall systems. You shall be solely responsible for deciding whether to adopt/use Epson products with your products.
5. Epson has prepared this document carefully to be accurate and dependable, but Epson does not guarantee that the information is always accurate and complete. Epson assumes no responsibility for any damages you incurred due to any misinformation in this document.
6. No dismantling, analysis, reverse engineering, modification, alteration, adaptation, reproduction, etc., of Epson products is allowed.
7. Epson products have been designed, developed and manufactured to be used in general electronic applications and specifically designated applications ("Anticipated Purpose"). Epson products are NOT intended for any use beyond the Anticipated Purpose that requires particular quality or extremely high reliability in order to refrain from causing any malfunction or failure leading to critical harm to life and health, serious property damage, or severe impact on society, including, but not limited to listed below ("Specific Purpose"). Therefore, you are strongly advised to use Epson products only for the Anticipated Purpose. Should you desire to purchase and use Epson products for Specific Purpose, Epson makes no warranty and disclaims with respect to Epson products, whether express or implied, including without limitation any implied warranty of merchantability or fitness for any Specific Purpose. Please be sure to contact our sales representative in advance, if you desire Epson products for Specific Purpose:
 - Space equipment (artificial satellites, rockets, etc.)/ Transportation vehicles and their control equipment (automobiles, aircraft, trains, ships, etc.) / Medical equipment/ Relay equipment to be placed on sea floor/ Power station control equipment / Disaster or crime prevention equipment/Traffic control equipment/ Financial equipment
 - Other applications requiring similar levels of reliability as the above
8. Epson products listed in this document and our associated technologies shall not be used in any equipment or systems that laws and regulations in Japan or any other countries prohibit to manufacture, use or sell. Furthermore, Epson products and our associated technologies shall not be used for the purposes of military weapons development (e.g. mass destruction weapons), military use, or any other military applications. If exporting Epson products or our associated technologies, please be sure to comply with the Foreign Exchange and Foreign Trade Control Act in Japan, Export Administration Regulations in the U.S.A (EAR) and other export-related laws and regulations in Japan and any other countries and to follow their required procedures.
9. Epson assumes no responsibility for any damages (whether direct or indirect) caused by or in relation with your non-compliance with the terms and conditions in this document or for any damages (whether direct or indirect) incurred by any third party that you give, transfer or assign Epson products.
10. For more details or other concerns about this document, please contact our sales representative.
11. Company names and product names listed in this document are trademarks or registered trademarks of their respective companies.