

REAL TIME CLOCK MODULE (SPI-Bus)
Built-in Temperature Sensor

RTC - 4701 JE / NB

- Built in frequency adjusted 32.768 kHz crystal unit.
- Interface Type : 3-wire serial interface
- Operating voltage range : 1.6 V to 5.5 V
- Wide Timekeeper voltage range : 1.6 V to 5.5 V
- Built-in temperature sensor : Detects temperature.
 Converts output to analog voltage
- 32.768 kHz frequency output function : C-MOS output With Control Pin
- Function of time and calendar, the various interrupt function etc.



Product Number (Please contact us)
 RTC-4701JE : Q41470171000200
 RTC-4701NB : Q41470191000200

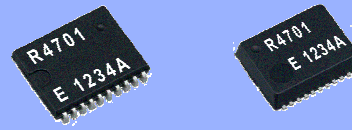

Actual size

RTC-4701JE

RTC-4701NB



Block diagram

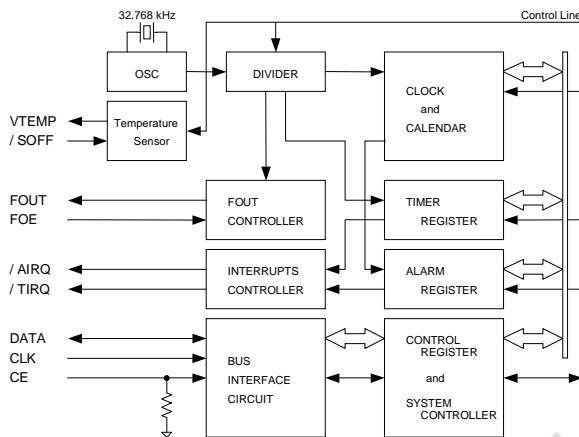

Overview

- **Built-in temperature sensor**
 - Diode temperature sensor (analog voltage output)
 - * Temperature sensor operating voltage : 2.7 V to 5.5 V
 - * Temperature sensor tolerance : $\pm 5^\circ\text{C}$ ($T_a = +25^\circ\text{C}$)
 - * Voltage output (analog): $-7.6\text{ mV} / ^\circ\text{C}$ Typ.
- **32.768 kHz frequency output function**
 - FOUT pin output (C-MOS output), CL=30 pF
 - FOE pin enables output on/off control.
- **The various interrupt function**
 - 12 bit additional counter. (to 4095 count)
 - Timer function can be set up between 1/4096 second and 255 minutes.
 - Alarm function can be set to day of week, hour, or minute.

Pin Function

Signal Name	Input / Output	Function						
CE	Input	The chip enabled input pin. (Built-in pull-down resistance)						
CLK	Input	The shift clock input pin for serial data transfer.						
DATA	Bi-directional	The data input / output pin for serial data transfer.						
FOUT	Output	<table border="1"> <tr> <th>FOE input</th> <th>FOUT output</th> </tr> <tr> <td>HIGH</td> <td>32.768 kHz output * C-MOS output</td> </tr> <tr> <td>LOW</td> <td>output OFF * Hi-z</td> </tr> </table>	FOE input	FOUT output	HIGH	32.768 kHz output * C-MOS output	LOW	output OFF * Hi-z
FOE input	FOUT output							
HIGH	32.768 kHz output * C-MOS output							
LOW	output OFF * Hi-z							
FOE	Input							
VTEMP	Output	The voltage output pin for the temperature sensor (analog).						
/SOFF	Input	The input pin for the temperature sensor control.						
/AIRQ	Output	Output 1 pin (N-ch open drain)						
/TIRQ	Output	Output 2 pin (N-ch open drain)						
V _{DD}	—	Connected to a positive power supply.						
GND	—	Connected to a ground.						

Terminal connection / External dimensions

(Unit:mm)

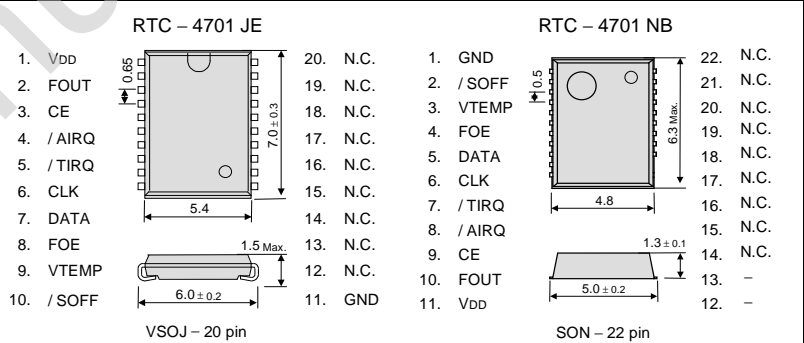

The metal case inside of the molding compound may be exposed on the top or bottom of this product. This purely cosmetic and does not have any effect on quality, reliability or electrical specs.

Temperature sensor characteristics

* Refer to application manual for details.

* If not specifically indicated, GND = 0 V, V_{DD} = 2.7 V to 5.5 V, T_a = -40 °C to +85 °C

Item	Symbol	Conditions	Min.	Typ.	Max.	Unit
Temperature output voltage	VTEMP	VTEMP pin, T _a = +25 °C GND based output voltage	-	1.480	-	V
Output tolerance	TACR	T _a = +25 °C	-	-	± 5.0	°C
Temperature sensitivity	VSE	-40 °C \leq T _a \leq +85 °C	-7.1	-7.6	-8.1	mV / °C
Linearity	ΔNL	-40 °C \leq T _a \leq +85 °C	-	-	± 2.0	%
Temperature detection range	T _{SOP}	$\Delta\text{NL} \leq \pm 2.0\%$	-40	-	+85	°C
Output resistance	R _O	VTEMP pin, T _a = +25 °C GND standard and V _{DD} standard	-	1.0	3.0	k Ω

* Temperature sensitivity $VSE = (V(+85^\circ\text{C}) - V(-40^\circ\text{C})) / 125$ [mV / °C]

* Linearity $\Delta\text{NL} = \frac{a}{b} \times 100$ [%]

* Output resistance (R_O) $R_O = \frac{\Delta V}{\Delta I}$ [Ω]

a : Maximum deviation between the measured value of VTEMP and approximate straight line.
 b : Difference between the measured values at -40 °C and +85 °C.

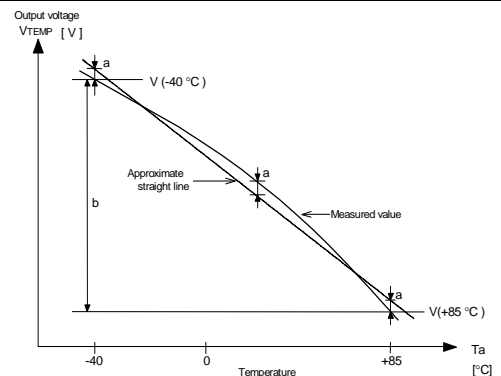

PROMOTION OF ENVIRONMENTAL MANAGEMENT SYSTEM CONFORMING TO INTERNATIONAL STANDARDS

At Seiko Epson, all environmental initiatives operate under the Plan-Do-Check-Action (PDCA) cycle designed to achieve continuous improvements. The environmental management system (EMS) operates under the ISO 14001 environmental management standard.

All of our major manufacturing and non-manufacturing sites, in Japan and overseas, completed the acquisition of ISO 14001 certification.

ISO 14000 is an international standard for environmental management that was established by the International Standards Organization in 1996 against the background of growing concern regarding global warming, destruction of the ozone layer, and global deforestation.





WORKING FOR HIGH QUALITY

In order provide high quality and reliable products and services than meet customer needs,

Seiko Epson made early efforts towards obtaining ISO9000 series certification and has acquired ISO9001 for all business establishments in Japan and abroad. We have also acquired ISO/TS 16949 certification that is requested strongly by major automotive manufacturers as standard.

ISO/TS16949 is the international standard that added the sector-specific supplemental requirements for automotive industry based on ISO9001.

► Explanation of the mark that are using it for the catalog

	► Pb free.
	► Complies with EU RoHS directive. *About the products without the Pb-free mark. Contains Pb in products exempted by EU RoHS directive. (Contains Pb in sealing glass, high melting temperature type solder or other.)
	► Designed for automotive applications such as Car Multimedia, Body Electronics, Remote Keyless Entry etc.
	► Designed for automotive applications related to driving safety (Engine Control Unit, Air Bag, ESC etc).

Notice

- This material is subject to change without notice.
- Any part of this material may not be reproduced or duplicated in any form or any means without the written permission of Seiko Epson.
- The information about applied data, circuitry, software, usage, etc. written in this material is intended for reference only. Seiko Epson does not assume any liability for the occurrence of customer damage or infringing on any patent or copyright of a third party. This material does not authorize the licensing for any patent or intellectual copyrights.
- When exporting the products or technology described in this material, you should comply with the applicable export control laws and regulations and follow the procedures required by such laws and regulations.
- You are requested not to use the products (and any technical information furnished, if any) for the development and/or manufacture of weapon of mass destruction or for other military purposes. You are also requested that you would not make the products available to any third party who may use the products for such prohibited purposes.
- These products are intended for general use in electronic equipment. When using them in specific applications that require extremely high reliability, such as the applications stated below, you must obtain permission from Seiko Epson in advance.
/ Space equipment (artificial satellites, rockets, etc.) / Transportation vehicles and related (automobiles, aircraft, trains, vessels, etc.) / Medical instruments to sustain life / Submarine transmitters / Power stations and related / Fire work equipment and security equipment / traffic control equipment / and others requiring equivalent reliability.
- All brands or product names mentioned herein are trademarks and/or registered trademarks of their respective.