

4-bit I/O CONNECTION REAL TIME CLOCK MODULE

RTC-58321/58323

- Built-in crystal unit allows adjustment-free efficient operation.
- Incorporating time counter (hour, minute, sec.) and calendar counter (year, month, day of week).
- Either 12 h or 24 h selectable and leap year automatically adjustable.
- Standard signal output selectable among a choice of 1024 Hz, 1 sec., 60 sec., and 1 hour.
- Provided with counter start, stop and reset functions.
- Data transmission is by 4-bit bidirectional bus line and memory read and write method.
- Low current consumption and backup function provided.

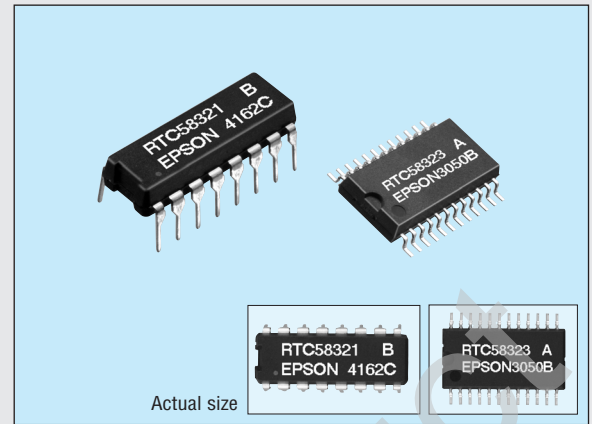

Specifications (characteristics)

Absolute Max. rating

Item	Symbol	Condition	Specifications	Unit
Power source voltage	V _{DD}	T _a =+25 °C	-0.3 to 6.5	V
Input and output voltage	V _{I/O}		-0.3 to V _{DD} +0.3	
storage temperature	T _{STG}	—	-55 to +85	°C
Soldering condition	T _{SOL}	RTC-58321	Under +260 °C within 10 s (lead part) (package should be less than +150 °C)	
		RTC-58323	Twice at under +260 °C within 10 s or under +230 °C within 3 min.	

Operating range

Item	Symbol	Condition	Specifications	Unit
Operating voltage	V _{DD}	—	4.5 to 5.5	V
Operating temperature	T _{OPR}	RTC-58321	-10 to +70	°C
		RTC-58323	-30 to +85	
Data holding voltage	V _{DH}	—	2.2 to 5.5	V
CSI data holding time	t _{CDR}	Refer to the data holding timing	0 Min.	μs
Operation restoring time	t _r			

Frequency characteristics and current consumption characteristics

Item	Symbol	Condition	Specifications	Unit	
Frequency tolerance	Δf/fo	T _a =+25 °C V _{DD} =5 V	58321 A	±10	x 10 ⁻⁶
			58321 B	±50	
			58323	5±20	
Frequency temperature characteristics	—	-10 °C to +70 °C (+25 °C reference temperature)	+10/-120		
Aging	f _a	V _{DD} =5 V, T _a =+25 °C, first year	±5 Max.	x 10 ³ /year	
Shock resistance	S.R.	Three drops on a hard board from 750 mm or 29400 m/s ² x 0.3 ms x 1/2 sine wave x 3 directions	±10 Max.	x 10 ⁻⁶	
Current consumption	I _{DD1}	V _{DD} =5 V, CS ₁ =0 V	40 Max.	μA	
	I _{DD2}	V _{DD} =3 V, CS ₁ =0 V	20 Max.		

DC characteristics

Item	Symbol	Condition	Min.	Typ.	Max.	Unit	Applicable terminal
"H" input voltage	V _{IH1}	—	3.6	—	—	V	Input other than CS ₁
"H" input voltage	V _{IH2}		V _{DD} -0.5	—	—		
"L" input voltage	V _{IL}	I _{OL} =1.6 mA	—	—	0.8		
"L" output voltage	V _{OL}		—	—	0.4		
"L" output current	I _{OL}	V _O =0.4 V	1.6	—	—	mA	
"H" input current	I _{IH}	V _I =5 V	10	30	80	μA	Input other than D ₀ to D ₃
"L" input current	I _{IL}	V _I =0 V	—	—	-1		
Input leak current	I _{L1H}	V _I =5 V	—	—	1	μA	D ₀ to D ₃
Input off leak current	I _{L1L}	V _I =0 V	—	—	-1		
Input capacity	C _I	Input frequency 1 MHz	—	5	—	pF	
Oscillation start-up time	t _{OSC}	V _{DD} =5 V T _a =+25 °C	1.5	3.0	—	s	Busy output

Terminal connection

RTC-58321

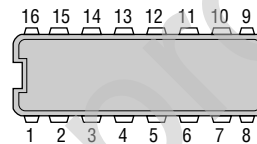

No.	58321	No.	58323
1	CS ₂	1 to 4	N.C
2	WRITE	5	CS ₂
3	READ	6	WRITE
4	D ₀	7	READ
5	D ₁	8	D ₀
6	D ₂	9	D ₁
7	D ₃	10	D ₂
8	GND	11	D ₃
9	ADDRESS WRITE	12	GND
10	BUSY	13	ADDRESS WRITE
11	STOP	14	BUSY
12	TEST	15	STOP
13	CS ₁	16	TEST
14 to 15	N.C	17	CS ₁
16	V _{DD}	18 to 24	V _{DD}

RTC-58323

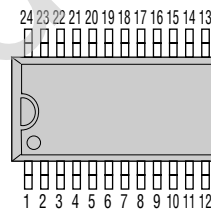

● NC is not connected internally.

External dimensions

(Unit: mm)

RTC-58321

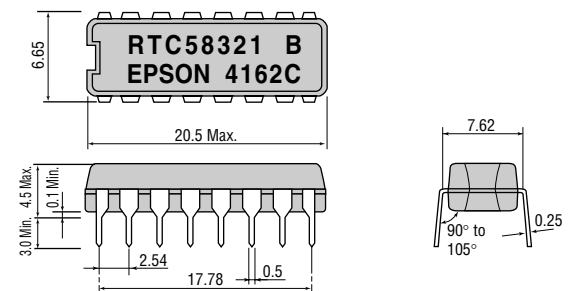

RTC-58323

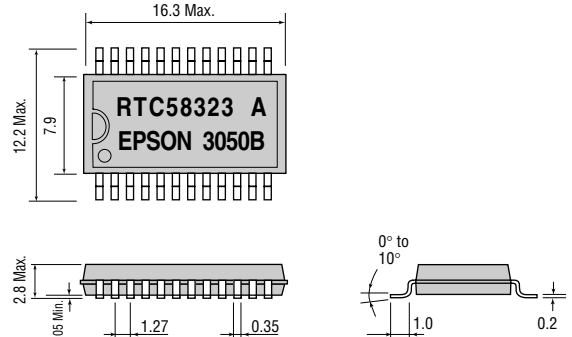

Supplement

0= "L" level 1= "H" level

Item	Description																									
* mark	Writable. Recognized as 0 while in read mode																									
24/12	"1" =24 h mode, "0" =12 h mode																									
PM/AM	"1" =PM, "0" =AM. In 24 h mode, this will be "0"																									
D ₃ and D ₂ of 10 days digit	Used to select leap year. Calculated according to the surplus after dividing 10 year digit by 4 <table border="1"> <thead> <tr> <th>Calendar</th> <th>D₃</th> <th>D₂</th> <th>Surplus after dividing 10 year digit by 4</th> <th>Example of leap year</th> </tr> </thead> <tbody> <tr> <td>Gregorian calendar</td> <td>0</td> <td>0</td> <td>0</td> <td>96, 00</td> </tr> <tr> <td></td> <td>1</td> <td>3</td> <td></td> <td></td> </tr> <tr> <td>Spare</td> <td>1</td> <td>0</td> <td>2</td> <td></td> </tr> <tr> <td></td> <td>1</td> <td>1</td> <td>1</td> <td></td> </tr> </tbody> </table>	Calendar	D ₃	D ₂	Surplus after dividing 10 year digit by 4	Example of leap year	Gregorian calendar	0	0	0	96, 00		1	3			Spare	1	0	2			1	1	1	
Calendar	D ₃	D ₂	Surplus after dividing 10 year digit by 4	Example of leap year																						
Gregorian calendar	0	0	0	96, 00																						
	1	3																								
Spare	1	0	2																							
	1	1	1																							
Reset register	These selections are for resetting 5-stage and the busy circuit after 1/2 ⁵ frequency stage. Resetting is activated by latching this code on to the address latch and setting WRITE=H																									
Standard signal register	By latching this code to the address latch and setting READ to H, the standard signals will be output at D ₀ to D ₃																									

- Note:
- Do not enter erroneous data for clock.
 - This may result in time keeping error.
 - Do not change STOP more than once while in BUSY mode.

Switching characteristics

Write & read mode

(V_{DD}=5 V±0.5 V)

Item	Symbol	Condition	Min.	Typ.	Max.	Unit.
CS setup time	t _{CS}		0			μs
Address setup time	t _{AS}		0.5			
Address write pulse width	t _{AW}		0.1			
Address hold time	t _{AH}		0			
Data setup time	t _{DS}		2			
Write pulse width	t _{WW}		0			
Data hold time	t _{CH}					
Read inhibit time	t _{RI}					
Read access time	t _{RA}				*1	
Read delay time	t _{DD}				1	
CS hold time	t _{CH}		0			

*1 t_{RA}=1 μs+C x R x ln [V_{DD}/(V_{DD}-V_H)]
 C: Data line capacity
 R: Pull-up resistance
 V_H: "H" input voltage connected to the data line
 ln: Natural logarithm

Date holding timing

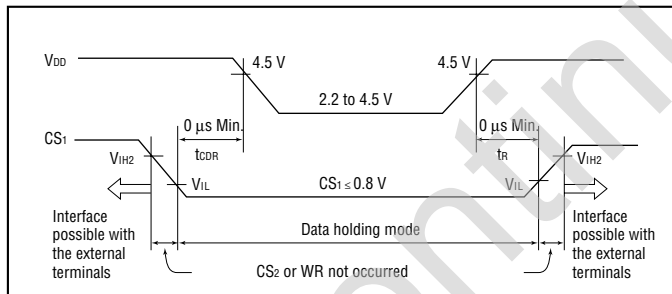

Register table

Address	D ₃	D ₂	D ₁	D ₀	Name of register	D ₃	D ₂	D ₁	D ₀	Count	Note	
	A ₃	A ₂	A ₁	A ₀		D ₃	D ₂	D ₁	D ₀			
0	0	0	0	0	S ₁	S ₈	S ₄	S ₂	S ₁	0 to 9	1 - sec. digit register	
1	0	0	0	1	S ₁₀	*	S ₄₀	S ₂₀	S ₁₀	0 to 5	10 - sec. digit register	
2	0	0	1	0	MI ₁	mi ₈	mi ₄	mi ₂	mi ₁	0 to 9	1 - min. digit register	
3	0	0	1	1	MI ₁₀	*	mi ₄₀	mi ₂₀	mi ₁₀	0 to 5	10 - min. digit register	
4	0	1	0	0	H ₁	h ₈	h ₄	h ₂	h ₁	0 to 9	1 - hour digit register	
5	0	1	0	1	H ₁₀	24/12	PM/AM	h ₂₀	h ₁₀	0 to 2 or 0 to 1	10 - hour digit register	
6	0	1	1	0	W	*	W ₄	W ₂	W ₁	0 to 6	Week register	
7	0	1	1	1	D ₁	d ₈	d ₄	d ₂	d ₁	0 to 9	1 - day digit register	
8	1	0	0	0	D ₁₀	Leap year selection			d ₂₀	d ₁₀	0 to 3	10 - day digit register
9	1	0	0	1	MO ₁	mo ₈	mo ₄	mo ₂	mo ₁	0 to 9	1 - month digit register	
A	1	0	1	0	MO ₁₀	*			mo ₁₀	0 to 1	10 - month digit register	
B	1	0	1	1	Y ₁	y ₈	y ₄	y ₂	y ₁	0 to 9	1 - year digit register	
C	1	1	0	0	Y ₁₀	y ₈₀	y ₄₀	y ₂₀	y ₁₀		10 - year digit register	
D	1	1	0	1	—	*						Reset register
E	1	1	1	0	—	1 hour	1 min.	1 sec.	1024 Hz			Standard signal register
F	1	1	1	1	—							

Write and read timing

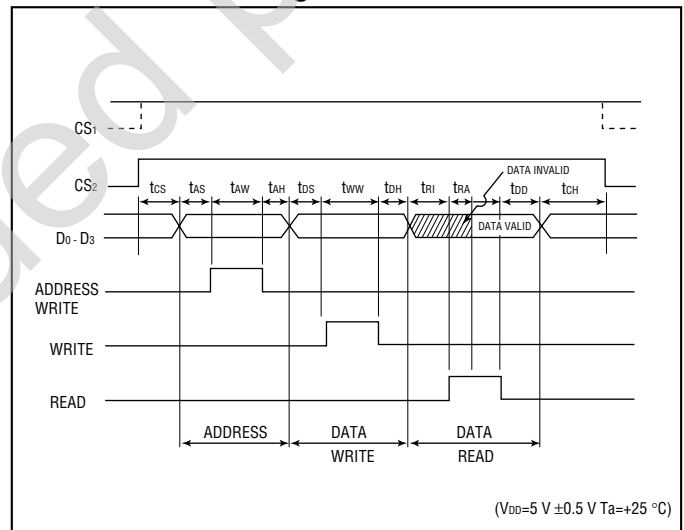

Block diagram

