

SAWデバイスラインナップ

	用途	周波数	バンド幅	品名	パッケージ	頁
セルラー RF	PCS ; TX	1880 MHz	60 MHz	TQS-915	SS-30S1 (B)	P. 89 } 91
	PCS ; RX	1960 MHz	60 MHz	TQS-916	SS-30S1 (B)	
	KOREA-PCS ; TX	1765 MHz	30 MHz	TQS-919	SS-30S1 (B)	
	KOREA-PCS ; RX	1855 MHz	30 MHz	TQS-920	SS-30S1 (B)	
	PDC1.5G ; TX	1441 MHz	24 MHz	TQS-829	SS-30S1 (B)	
	PDC1.5G ; RX	1489 MHz	24 MHz	TQS-828	SS-30S1 (B)	
	PDC ; TX	950 MHz	20 MHz	TQS-875	SS-30S1 (B)	
	PDC ; RX	820 MHz	20 MHz	TQS-876	SS-30S1 (B)	
	PDC巻取り ; RX	826.5/877.5 MHz	33/25 MHz	TQS-857	SS-30S1 (C)	
	GSM ; TX	902.5 MHz	25 MHz	TQS-873	SS-30S1 (B)	
	GSM ; RX	947.5 MHz	25 MHz	TQS-874	SS-30S1 (B)	
	EGSM ; RX	942.5 MHz	35 MHz	TQS-863	SS-30S1 (B)	
	AMPS ; TX	836.5 MHz	25 MHz	TQS-917	SS-30S1 (B)	
	AMPS ; RX	881.5 MHz	25 MHz	TQS-918	SS-30S1 (B)	
	N-CDMA ; TX	906 MHz	38 MHz	TQS-847	SS-30S1 (B)	
	N-CDMA ; RX	851 MHz	38 MHz	TQS-848	SS-30S1 (B)	
セルラー IF	GSM	71 MHz	160 kHz	TQS-843	SS-952 (D)	P. 92 ・ 93
	GSM	246 MHz	160 kHz	TQS-650	SS-752 (D)	
	GSM	276 MHz	160 kHz	TQS-654	SS-752 (D)	
	AMPS	85.38 MHz	30 kHz	TQS-642	SS-11052 (A)	
	N-CDMA	85.38 MHz	1240 kHz	TQS-454	SS-15072 (B)	
	N-CDMA	210.38 MHz	1240 kHz	TQS-455	SS-952 (G)	
ページャ	日本, アジア	280,284 MHz	8 MHz	TQS-446	SS-38S1 (A)	P. 95
		280,284 MHz	8 MHz	TQS-844	SS-38S1 (A)	
	米国, 欧州, アジア	150 MHz帯	7~9 MHz	TQS-445	SS-541 (F)	
		150 MHz帯	7~9 MHz	TQS-860	SS-38S1 (A)	
		450 MHz帯	4 MHz	TQS-821	SS-541 (F)	
コードレス	US-CT	903.5/926.5 MHz	2/2 MHz	TQS-833	SS-541 (H)	P. 94
その他	ETC ; IF	40 MHz	5 MHz	TQS-453	SS-541 (L)	P. 96
	キーレスエントリー	315 MHz	30 kHz	TQS-651	SS-752 (D)	
	ワイヤレスラン	280 MHz	17 MHz	TQS-444	SS-541 (F)	
	特定小電力	429.55 MHz	0.8 MHz	TQS-830	SS-541 (F)	

製品データ

セルラーRF用

仕様

品番	TQS-915A-7R	TQS-916A-7R	TQS-919A-7R	TQS-920A-7R	TQS-829A-7R	TQS-828A-7R
公称周波数 (fo)	1880 MHz	1960 MHz	1765 MHz	1855 MHz	1441 MHz	1489 MHz
通過帯域幅	1850 ~ 1910 MHz	1930 ~ 1990 MHz	1750 ~ 1780 MHz	1840 ~ 1870 MHz	1429 ~ 1453 MHz	1477 ~ 1501 MHz
帯域内最大損失	4.1 dB Max.	4.1 dB Max.	3.0 dB Max.	3.0 dB Max.	2.5 dB Max.	2.5 dB Max.
帯域内偏差	3.0 dB Max.	3.0 dB Max.	1.5 dB Max.	1.5 dB Max.	1.5 dB Max.	1.5 dB Max.
VSWR	2.8 Max.	2.5 Max.	2.0 Max.	2.0 Max.	2.5 Max.	2.5 Max.
減衰量	DC ~ 1500 MHz : 21 dB Min 1500 ~ 1800 MHz : 25 dB Min 1930 ~ 1960 MHz : 10 dB Min 1960 ~ 1990 MHz : 30 dB Min 1990 ~ 2200 MHz : 26 dB Min 3700 ~ 3820 MHz : 25 dB Min 5550 ~ 5730 MHz : 15 dB Min	DC ~ 1500 MHz : 20 dB Min 1500 ~ 1850 MHz : 23 dB Min 1850 ~ 1895 MHz : 30 dB Min 1895 ~ 1910 MHz : 10 dB Min 2070 ~ 2350 MHz : 23 dB Min 2350 ~ 3000 MHz : 26 dB Min 3860 ~ 3980 MHz : 26 dB Min 5790 ~ 5970 MHz : 15 dB Min	1350 ~ 1380 MHz : 25 dB Min 1660 ~ 1690 MHz : 30 dB Min 1840 ~ 1870 MHz : 30 dB Min 2150 ~ 2180 MHz : 30 dB Min 5220 ~ 5340 MHz : 10 dB Min	1440 ~ 1470 MHz : 25 dB Min 1750 ~ 1780 MHz : 30 dB Min 1930 ~ 1960 MHz : 30 dB Min 2240 ~ 2270 MHz : 30 dB Min	1477 ~ 1501 MHz : 13 dB Min 2858 ~ 2906 MHz : 25 dB Min 4287 ~ 4359 MHz : 7 dB Min	1429 ~ 1453 MHz : 15 dB Min 1607 ~ 1631 MHz : 30 dB Min 1737 ~ 1761 MHz : 35 dB Min
終端インピーダンス	50 Ω	50 Ω	50 Ω	50 Ω	50 Ω	50 Ω
使用温度範囲	-30 ~ +85°C	-30 ~ +85°C	-30 ~ +85°C	-30 ~ +85°C	-20 ~ +75°C	-20 ~ +75°C
パッケージ	SS-30S1 (B)	SS-30S1 (B)	SS-30S1 (B)	SS-30S1 (B)	SS-30S1 (B)	SS-30S1 (B)

電気的特性

TQS-915A-7R

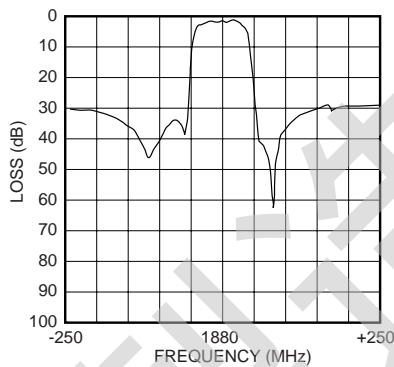

TQS-916A-7R

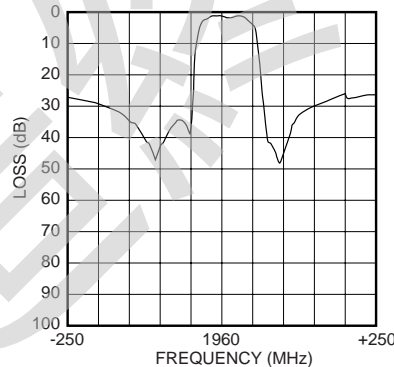

TQS-919A-7R

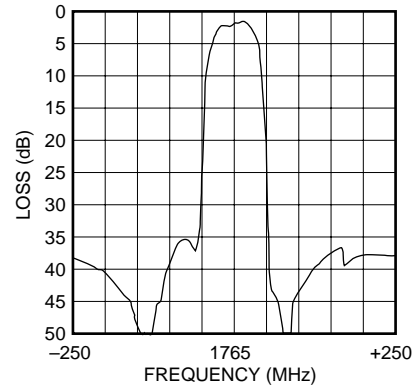

TQS-920A-7R

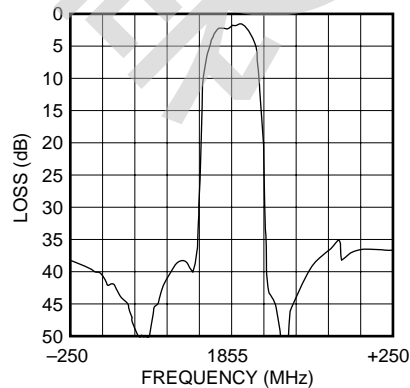

TQS-829A-7R

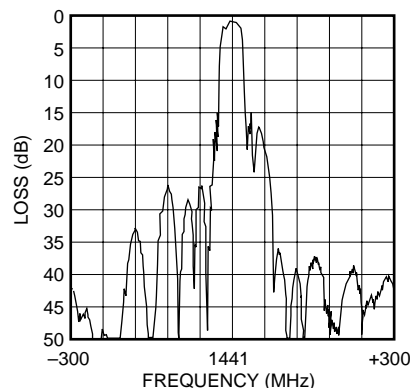

TQS-828A-7R

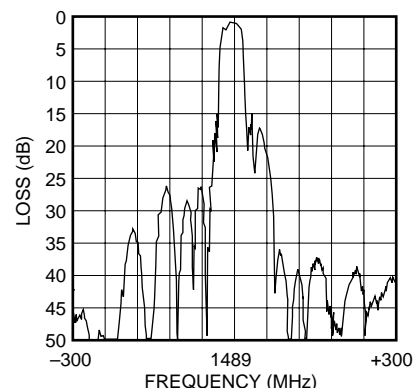

製品データ

セルラーRF用

仕様

品番	TQS-875A-7R	TQS-876A-7R	TQS-857A-7R		TQS-873A-7R	TQS-874A-7R
公称周波数 (f ₀)	950 MHz	820 MHz	826.5 MHz	877.5 MHz	902.5 MHz	847.5 MHz
通過帯域幅	940 ~ 960 MHz	810 ~ 830 MHz	810 ~ 843 MHz	870 ~ 885 MHz	890 ~ 915 MHz	935 ~ 960 MHz
帯域内最大損失	3.5 dB Max.	3.5 dB Max.	2.6 dB Max.	2.6 dB Max.	3.5 dB Max.	3.8 dB Max.
帯域内偏差	1.5 dB Max.	1.5 dB Max.	1.5 dB Max.	1.0 dB Max.	1.5 dB Max.	1.8 dB Max.
V S W R	2.5 Max.	2.5 Max.	2.5 Max.	2.5 Max.	2.5 Max.	2.5 Max.
減衰量	810 ~ 830 MHz : 45 dB Min 1620 ~ 1920 MHz : 30 dB Min 2820 ~ 2880 MHz : 15 dB Min	550 ~ 570 MHz : 45 dB Min 680 ~ 700 MHz : 45 dB Min 940 ~ 960 MHz : 45 dB Min 1070 ~ 1090 MHz : 45 dB Min	550 ~ 583 MHz : 40 dB Min 680 ~ 713 MHz : 23 dB Min 745 ~ 778 MHz : 20 dB Min 893 ~ 898 MHz : 18 dB Min 925 ~ 960 MHz : 25 dB Min	610 ~ 625 MHz : 40 dB Min 740 ~ 755 MHz : 25 dB Min 805 ~ 820 MHz : 20 dB Min 925 ~ 940 MHz : 20 dB Min	935 ~ 980 MHz : 30 dB Min 1780 ~ 1830 MHz : 40 dB Min 2670 ~ 2745 MHz : 20 dB Min	890 ~ 915 MHz : 30 dB Min 980 ~ 1100 MHz : 20 dB Min 1100 ~ 1350 MHz : 40 dB Min 1350 ~ 1600 MHz : 50 dB Min
終端インピーダンス	50 Ω	50 Ω	入力 : 50 Ω // 10nH, 出力 : 50 Ω		50 Ω	50 Ω
使用温度範囲	-20 ~ +75°C	-20 ~ +75°C	-20 ~ +75°C		-20 ~ +75°C	-20 ~ +75°C
パッケージ	SS-30S1 (B)	SS-30S1 (B)	SS-30S1 (C)		SS-30S1 (B)	SS-30S1 (B)

電気的特性

TQS-857A-7R 826.5MHz

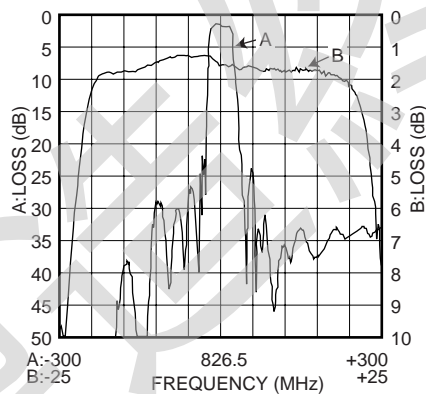

TQS-857A-7R 877.5MHz

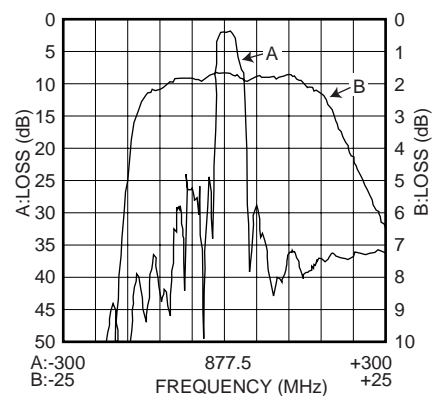

TQS-873A-7R

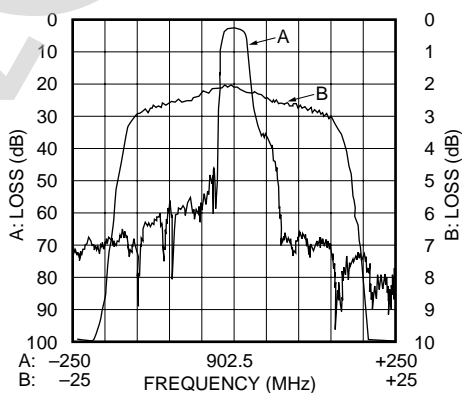

製品データ

セルラーRF用

仕様

品番	TQS-863A-7R	TQS-917A-7R	TQS-918A-7R	TQS-847A-7R	TQS-848A-7R
公称周波数 (fo)	942.5 MHz	836.5 MHz	881.5 MHz	906 MHz	851 MHz
通過帯域幅	925 ~ 960 MHz	824 ~ 849 MHz	869 ~ 894 MHz	887 ~ 925 MHz	832 ~ 870 MHz
帯域内最大損失	2.5 dB Max.	3.0 dB Max.	3.0 dB Max.	4.0 dB Max.	4.0 dB Max.
帯域内偏差	1.5 dB Max.	2.0 dB Max.	2.0 dB Max.	2.0 dB Max.	2.0 dB Max.
VSWR	2.5 Max.	2.0 Max.	2.0 Max.	3.0 Max.	3.0 Max.
減衰量	880 ~ 905 MHz : 20 dB Min 905 ~ 915 MHz : 8 dB Min -10 ~ +75°C : 8 dB Min +25°C : 10 dB Min 980 ~ 1100 MHz : 8 dB Min -10 ~ +75°C : 8 dB Min +25°C : 10 dB Min 1100 ~ 1250 MHz : 35 dB Min 1250 ~ 1400 MHz : 25 dB Min 1400 ~ 2000 MHz : 35 dB Min	DC ~ 800 MHz : 24 dB Min 869 ~ 894 MHz : 25 dB Min 894 ~ 1049 MHz : 30 dB Min 1049 ~ 2000 MHz : 20 dB Min	DC ~ 779 MHz : 24 dB Min 779 ~ 824 MHz : 30 dB Min 824 ~ 849 MHz : 30 dB Min 914 ~ 939 MHz : 25 dB Min 939 ~ 2000 MHz : 25 dB Min	722 ~ 760 MHz : 40 dB Min 832 ~ 870 MHz : 8 dB Min 1774 ~ 1850 MHz : 40 dB Min 2661 ~ 2775 MHz : 20 dB Min	612 ~ 650 MHz : 50 dB Min 722 ~ 760 MHz : 30 dB Min 887 ~ 925 MHz : 10 dB Min
終端インピーダンス	入力: 50 Ω // 10nH, 出力: 50 Ω	50 Ω	50 Ω	50 Ω	50 Ω
使用温度範囲	-10 ~ +75°C	-30 ~ +85°C	-30 ~ +85°C	-20 ~ +75°C	-20 ~ +75°C
パッケージ	SS-30S1 (B)	SS-30S1 (B)	SS-30S1 (B)	SS-30S1 (B)	SS-30S1 (B)

電気的特性

TQS-863A-7R

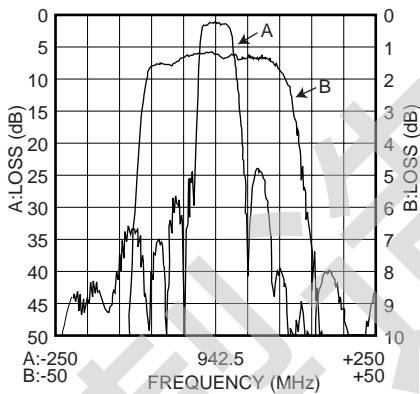

TQS-917A-7R

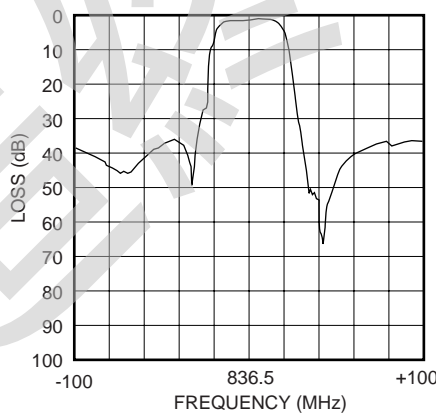

TQS-918A-7R

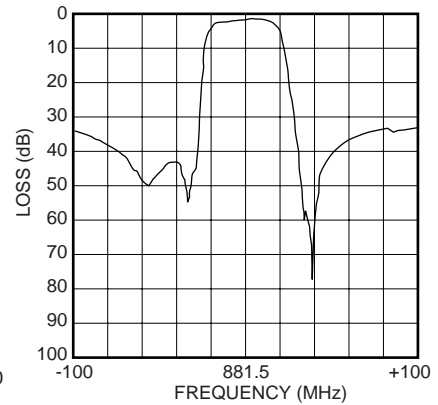

TQS-847A-7R

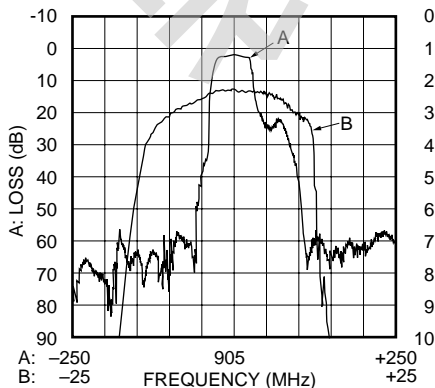

TQS-848A-7R

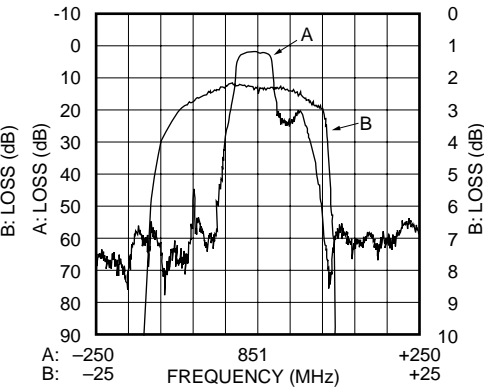

製品データ

セルラーIF用

仕様

品番	TQS-843A-7R	TQS-650A-7R	TQS-654A-7R	TQS-642A-7R
公称周波数 (fo)	71 MHz	246 MHz	276 MHz	85.38 MHz
通過帯域幅	fo±80 kHz Min	fo±80 kHz Min	fo±80 kHz Min	fo±15 kHz Min
挿入損失	4.0 dB Max.	6.0 dB Max.	6.0 dB Max.	4.0 dB Max.
リップル	1.5 dB Max.	1.0 dB Max.	1.0 dB Max.	1.5 dB Max.
群遅延時間偏差	2.0 μsec Max.	1.5 μsec Max.	2.0 μsec Max.	10 μsec Max.
減衰量	fo±400 kHz: 20 dB Min. fo±600 kHz: 30 dB Min. fo±800 kHz: 40 dB Min. fo±1.6 MHz: 45 dB Min.	fo±400 kHz: 20 dB Min. fo±600 kHz: 35 dB Min. fo±800 kHz: 35 dB Min. fo±3 MHz: 50 dB Min.	fo±400 kHz: 25 dB Min. fo±600 kHz: 40 dB Min. fo±800 kHz: 45 dB Min.	fo±60 kHz: 20 dB Min. fo-900 kHz: 70 dB Min.
終端インピーダンス	1 kΩ/-2.2 pF	730 Ω/-1.7 pF	700 Ω/-1.2 pF	900 Ω/-1.5 pF
使用温度範囲	-20 ~ +75°C	-20 ~ +70°C	-20 ~ +70°C	-30 ~ +70°C
パッケージ	SS-952 (D)	SS-752 (D)	SS-752 (D)	SS-11052 (A)

電気的特性

TQS-843A-7R

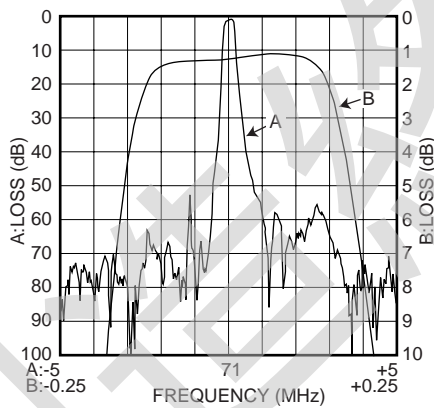

TQS-650A-7R

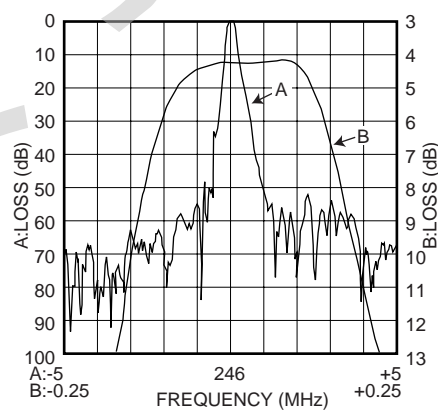

TQS-654A-7R

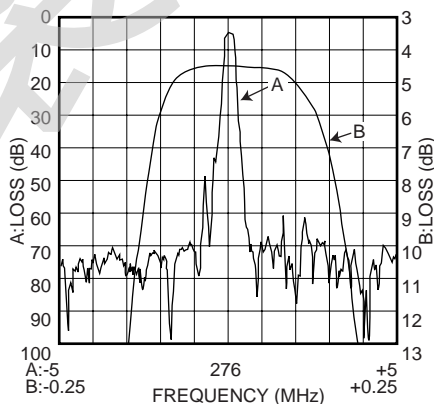

TQS-642A-7R

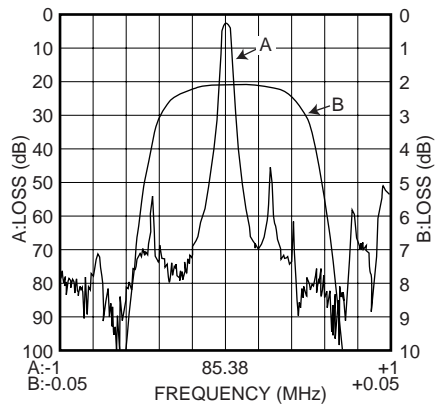

製品データ

セルラーIF用

仕様

品番	TQS-454A-7R	TQS-454B-7R	TQS-455A-7R
公称周波数 (fo)	85.38 MHz	111.85 MHz	210.85 MHz
通過帯域幅	fo±614 kHz Min	fo±610 kHz Min	fo±620 kHz Min
挿入損失	14.0 dB Max.	14.0 dB Max.	10.0 dB Max.
リップル	0.7 dB Max (fo±0.3 MHz)	0.7 dB Max (fo±0.3 MHz)	0.7 dB Max (fo±0.3 MHz)
群遅延時間偏差	500 nsec Max (fo±0.3 MHz) 800 nsec Max (fo±0.61 MHz)	400 nsec Max (fo±0.3 MHz) 800 nsec Max (fo±0.61 MHz)	250 nsec Max (fo±0.3 MHz) 500 nsec Max (fo±0.61 MHz)
減衰量	fo±900 kHz: 33 dB Min. fo±9 MHz: 45 dB Min.	fo±900 kHz: 33 dB Min. fo±9 MHz: 40 dB Min.	fo±1.25 MHz: 33 dB Min. fo±9 MHz: 45 dB Min.
終端インピーダンス	入力: 1.4 kΩ/-14 pF 出力: 0.9 kΩ/-11 pF	入力: 530 Ω/-16 pF 出力: 570 kΩ/-12 pF	入力: 310 Ω/-11 pF 出力: 360 Ω/-8 pF
使用温度範囲	-30 ~ +85°C	-30 ~ +85°C	-30 ~ +80°C
パッケージ	SS-15072 (B)	SS-15072 (B)	SS-952 (G)

電気的特性

TQS-454A-7R

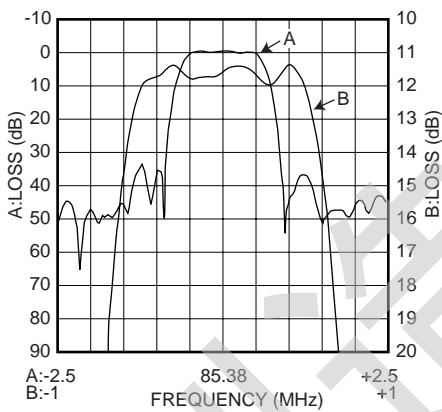

TQS-454B-7R

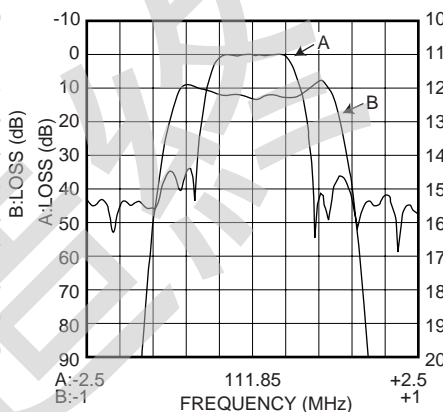

TQS-455A-7R

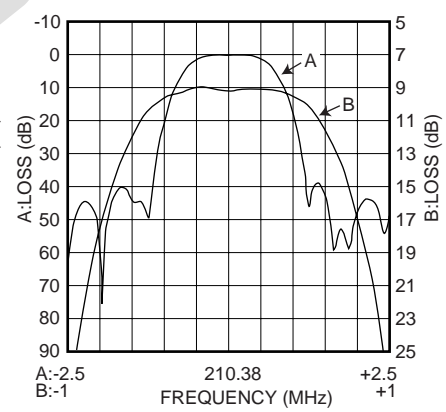

製品データ

コードレスRF用

仕様	
品番	TQS-833B-7R
公称周波数 (f o)	903.5 MHz (f ₁) 926.5 MHz (f ₂)
通過帯域幅	2 MHz
帯域内最大損失	3.5 dB Max.
減衰量	f ₁ -80MHz ~ f ₁ -40MHz: 35dB Min. f ₂ -80MHz ~ f ₂ -40MHz: 35dB Min.
	f ₁ ±40MHz ~ f ₁ ±22MHz: 25dB Min. f ₂ ±40MHz ~ f ₂ ±22MHz: 25dB Min.
	f ₁ +60MHz ~ f ₁ +100MHz: 40dB Min. f ₂ +60MHz ~ f ₂ +100MHz: 40dB Min.
入力電力	10mW Max.
終端インピーダンス	50 Ω
使用温度範囲	-10 ~ +50°C
パッケージ	SS-541 (H)

電気的特性

TQS-833B-7R (f₁)

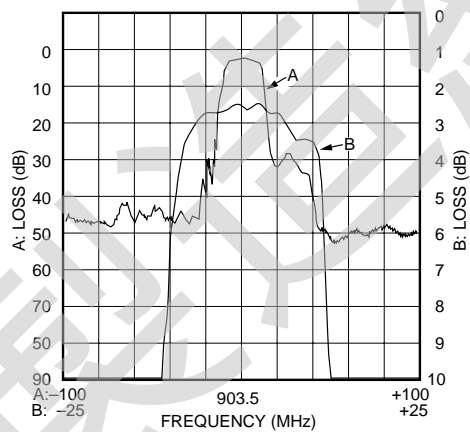

TQS-833B-7R (f₂)

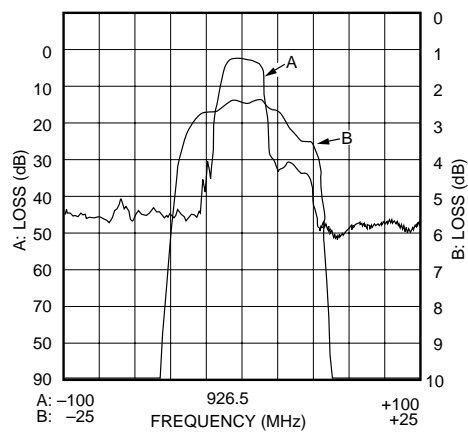

製品データ

ページャRF用

仕様

品番	TQS-446A-7R	TQS-844A-7R	TQS-445A-7R	TQS-860A-7R	TQS-821B-7R
公称周波数 (fo)	280, 284 MHz	280, 284 MHz	139, 147, 155.5, 163.5, 171 MHz	138.5, 148, 154, 162.5, 171.5 MHz	422 ~ 478 MHz
通過帯域幅	fo±4 MHz	fo±4 MHz	fo±3.5 ~ 4.5 MHz	fo±3.5 ~ 4.5 MHz	fo±2 MHz Min
帯域内最大損失	5 dB Max.	4.5 dB Max.	6.5 dB Max.	4.0 dB Max.	4.5 dB Max.
減衰量	100 ~ 221 MHz: 50 dB Min. 305 ~ 380 MHz: 40 dB Min.	fo-100MHz ~ fo-38.8MHz: 55dB Min. fo+20MHz ~ fo+38.8MHz: 35dB Min. fo+38.8MHz ~ fo+100MHz: 50dB Min.	PB-42.8MHz: 50dB Min PB+42.8MHz: 42dB Min	PB-42.8MHz: 55dB Min PB+42.8MHz: 50dB Min	DC ~ 40.8MHz: 50dB Min fo+30 ~ fo+200MHz: 50dB Min
終端インピーダンス	270 Ω// -5 pF	230 Ω//0 pF	500 Ω// -7 ~ -9 pF	440 Ω// -1.0 pF	150 Ω//0 pF
使用温度範囲	-10 ~ +50 °C	-10 ~ +50 °C	-10 ~ +50 °C	-10 ~ +50 °C	-10 ~ +50 °C
パッケージ	SS-38S1 (A)	SS-38S1 (A)	SS-541 (F)	SS-38S1 (A)	SS-541 (F)

電気的特性

TQS-446A-7R

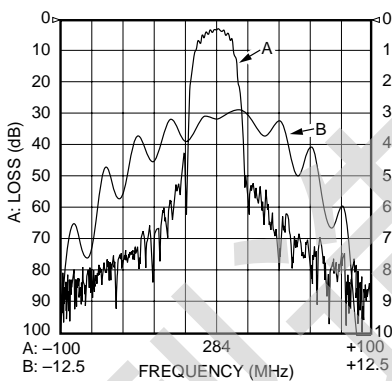

TQS-844A-7R

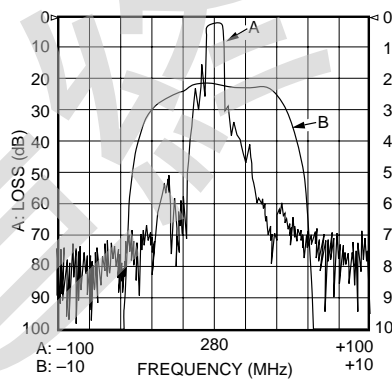

TQS-445A-7R

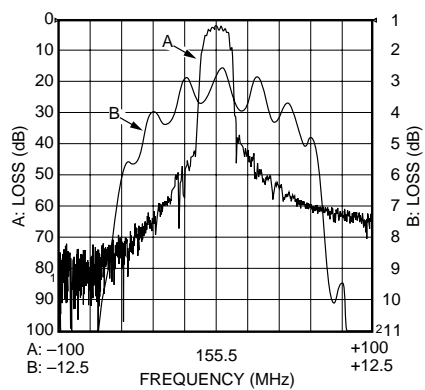

TQS-860A-7R

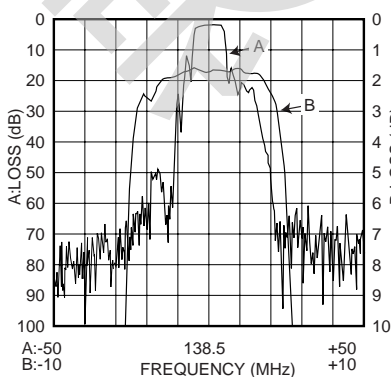

TQS-821B-6R

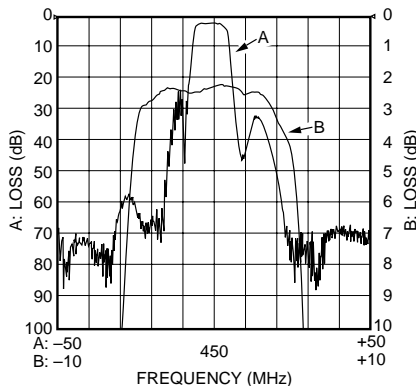

製品データ

その他（キーレス、特定小電力、ワイヤレスラン）

仕様

品番	TQS-830A-7R	TQS-444F-7R	TQS-651A-7R	TQS-453A-7R
公称周波数 (fo)	429.55MHz	280 MHz	315 MHz	40 MHz
通過帯域幅	fo±0.4 MHz	fo±8.5 MHz	fo±15 kHz Min	fo±2.5 MHz Min
帯域内最大損失	3.5 dB Max.	10 dB Max.	5.0 dB Max.	13 dB Max.
減衰量	fo ±42.4 MHz: 55 dB Min.	fo±38.8 MHz: 50 dB Min.	fo-910 kHz: 50 dB Min.	fo±10 MHz: 40 dB Min.
終端インピーダンス	50 Ω	270 Ω // -5 pF	350 Ω // -1.0 pF	600 Ω // -8.6 pF
使用温度範囲	-10 ~ +50 °C	-10 ~ +50 °C	-20 ~ +75 °C	-25 ~ +90 °C
パッケージ	SS-541(F)	SS-541(F)	SS-752(D)	SS-541(L)

電気的特性

TQS-830A-7R

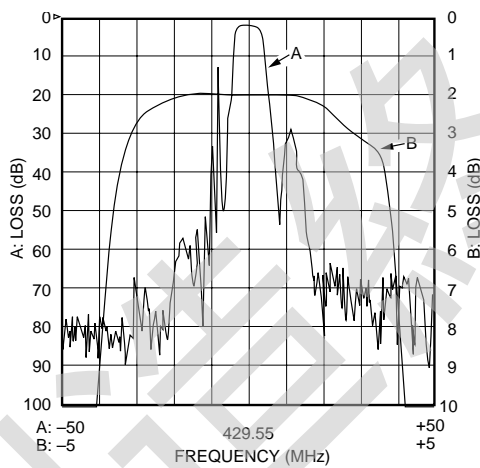

TQS-444F-7R

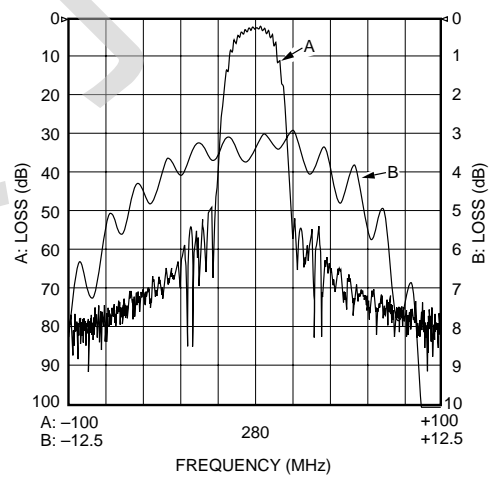

TQS-651A-7R

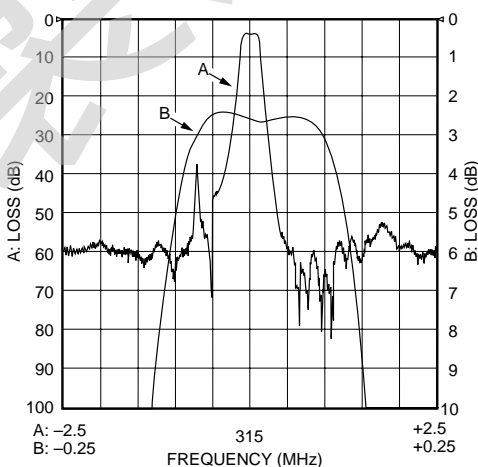

TQS-453A-7R

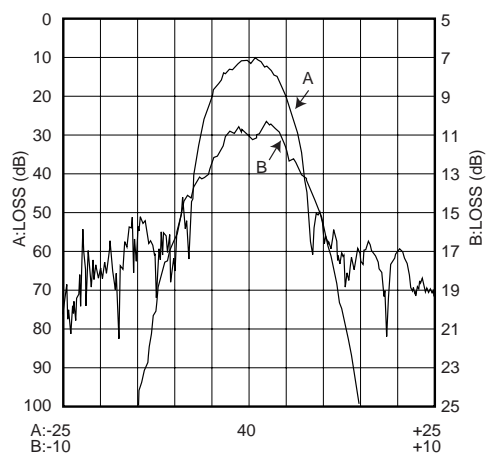

パッケージ外形寸法図〔単位：mm〕

SS-30S1 (B)

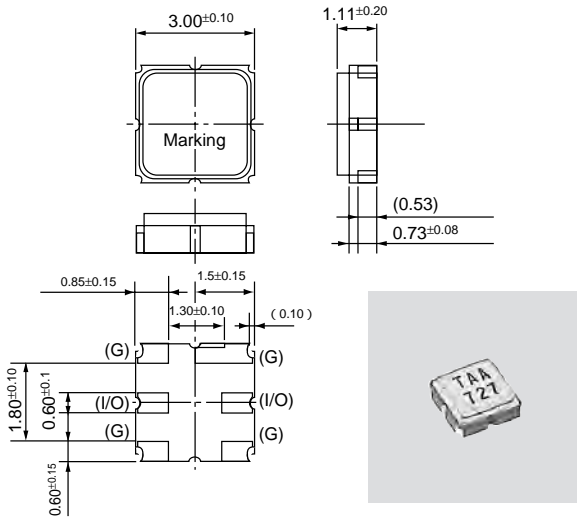

SS-38S1 (A)

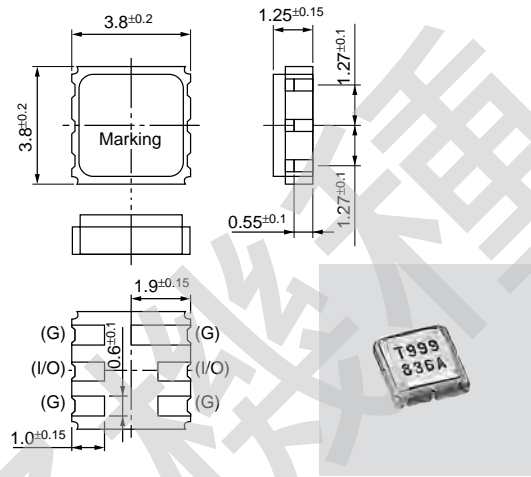

SS-30S1 (C)

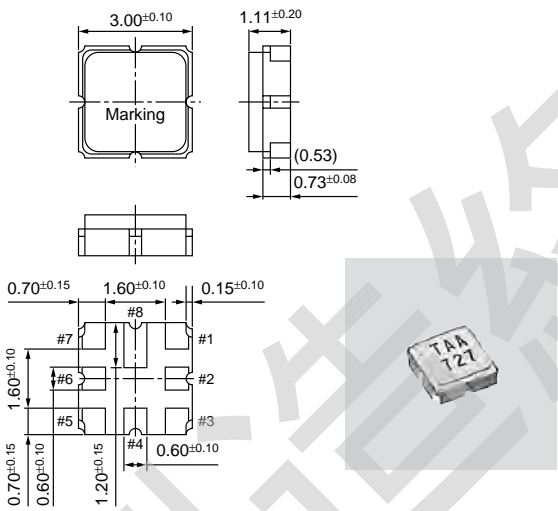

SS-541 (H)

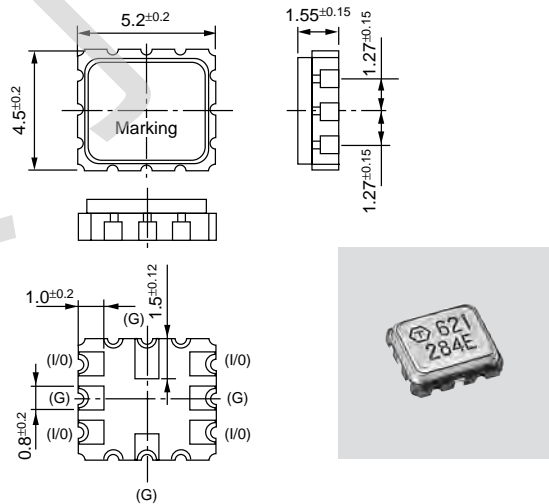

SS-541 (F)

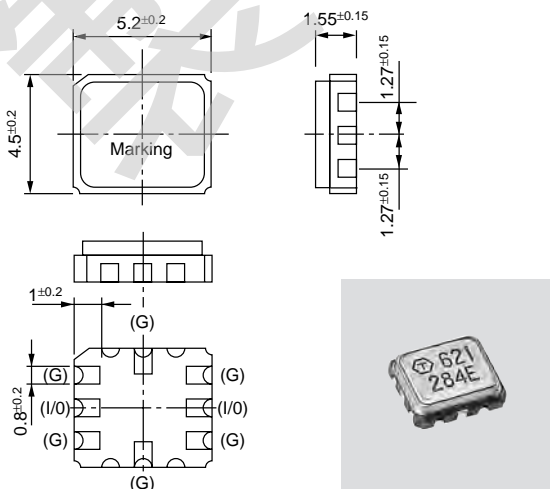

SS-752 (D)

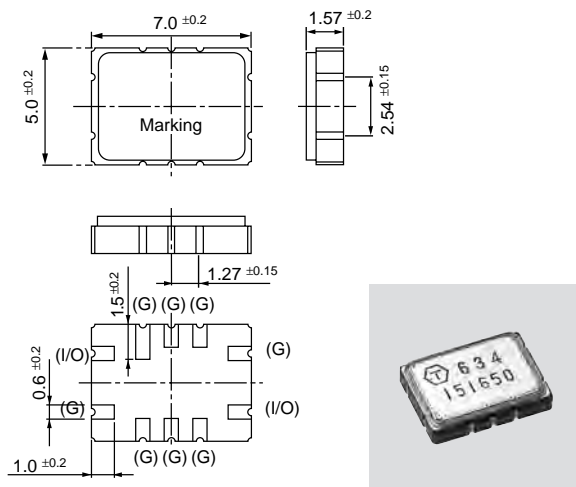

パッケージ外形寸法図〔単位：mm〕

SS-15072 (B)

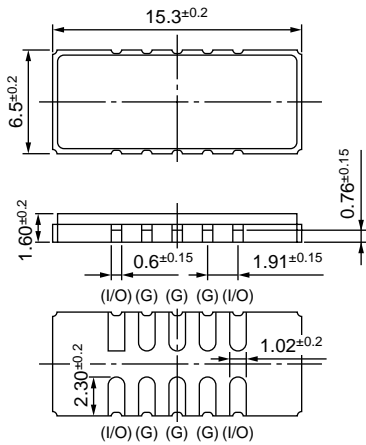

SS-541 (L)

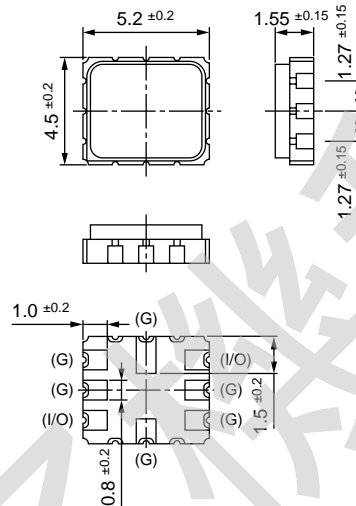

SS-11052 (A)

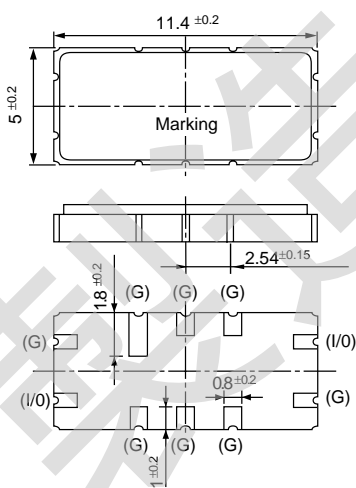

SS-952 (D)

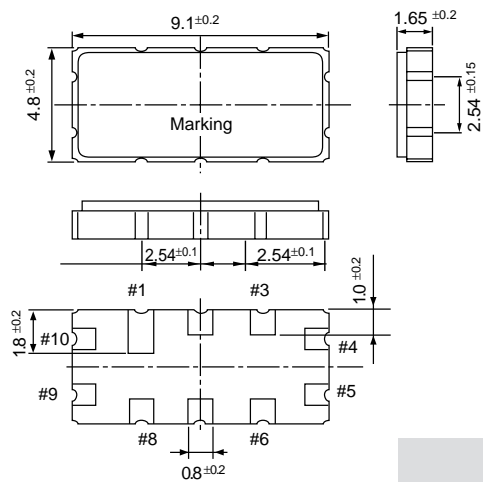

SAWデバイス

パッケージ外形寸法図〔単位：mm〕

SS-952 (G)

